

12040
Olivine Basalt
319 grams



Figure 1: Photo of freshly broken surface of 12040,30. NASA #S74-33936. Sample is about 2 inches tall. (A distinctly pink grain can be seen in the top corner of this photo).

Introduction

Lunar basalt 12040 is a slowly cooled olivine basalt with a high proportion of mafic minerals. This rock is roughly equigranular in texture, the largest crystals being 3-4 mm in length and the average grain size 1 mm (Champness et al. 1971). It has been successfully dated at about 3.3 b.y.

Petrography

Walter et al. (1971), Brown et al. (1971), Newton et al. (1971), Champness et al. (1971) and Baldrige et al. (1979) discuss the petrology of 12040 and found evidence of accumulation of olivine. Hence the composition of 12040 does not represent that of a parent liquid. French et al. (1972) describe 12040 as “a holocrystalline coarse-grained rock composed chiefly of pyroxene and olivine with minor plagioclase and

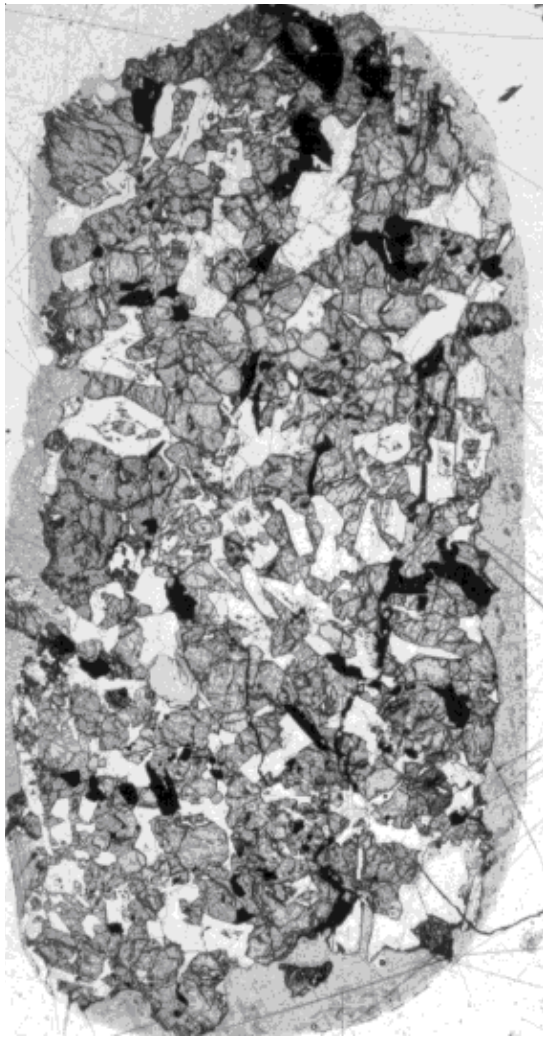

Figure 2: Photo of thin section of 12040,2. Length is 2 cm. NASA S#70-20750.

opaque phases. Olivine occurs as clear equant anheda or subhedra about 1 mm in size. Plagioclase occurs interstitially to olivine and pyroxene". They noted no shock effects.

A further complication is that the composition of the olivine is more iron rich than would have formed from a liquid with this composition (Mg rich). Olivine may have formed late and/or re-equilibrated as the rock cooled. Pyroxene, however, does not trend towards Fe enrichment.

The olivine and pyroxene in 12040 contain abundant melt inclusions (Newton et al. 1971).

Mineralogy

Olivine: Baldrige et al. (1979) reported the average olivine as Fo₅₈. Newton et al. (1971) found that olivine

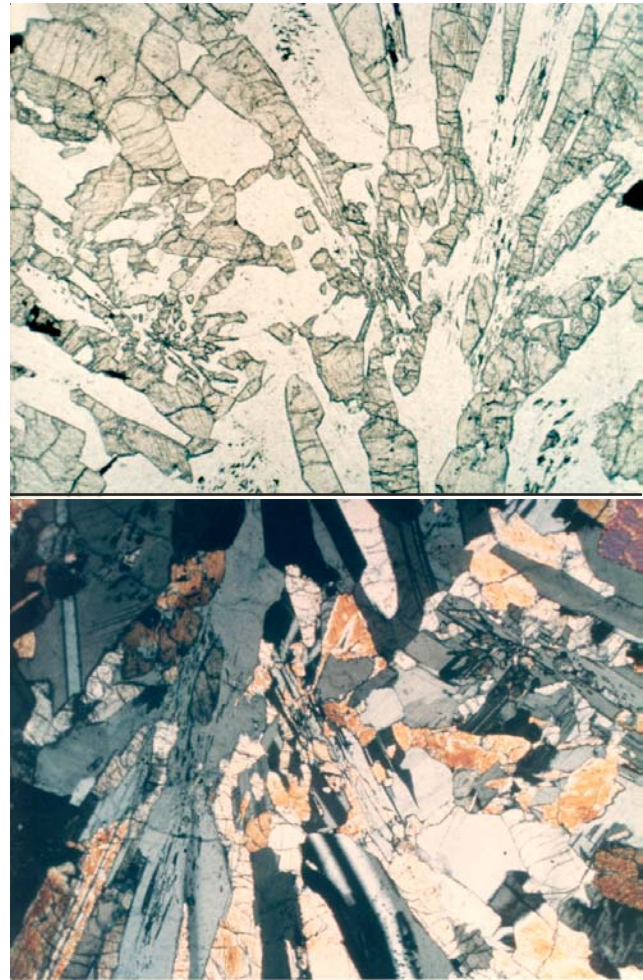

Figure 3: Photomicrographs of thin section 12040,3 (plane-polarized, crossed-nicols). Field of view about 2.6 mm. NASA #S70-49441 and 49442.

occurs both as large inclusions in augite-pigeonite megacrysts and as separate grains associated with small pyroxene. Walter et al. (1971) reported that some olivine grains in 12040 (Fo₅₃₋₃₈) are relatively small and occur interstitially to larger pyroxene crystals. Based on Cr analysis, Champness et al. (1971) describe two distinct groups of olivine crystals in 12040.

Pyroxene: Walter et al. (1971) and Brown et al. (1971) found that there was no Fe-rich pyroxene due to slow crystallization of 12040 (figure 4). Some pyroxene grains are up to 6 mm in size.

Plagioclase: Plagioclase in 12040 is An₉₂₋₉₅ (Walter et al. 1971).

Opakes: Ilmenite occurs as embayed and hollow laths up to 500 microns long in 12040 (Champness et al. 1971). Chromite octahedral (75 microns), with rare

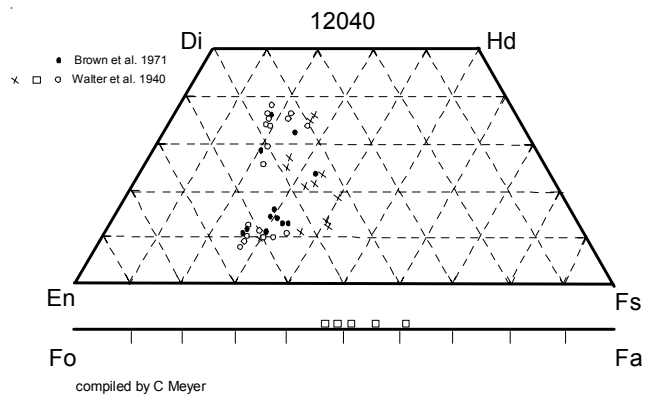

Figure 4: Olivine and pyroxene composition of 12040 (adapted from Walter et al. 1971 and Brown et al. 1971).

ulvöspinel rims, occur within olivine. Ilmenite lamellae occur in spinel. Troilite with native iron blebs occur in the mesostasis.

Metallic iron: Ni and Co contents have been determined in minute iron grains in 12040 (Brett et al. 1971, Walter et al. 1971, figure 5 and 6).

Phosphates: Brown et al. (1971) and French et al. (1972) determined the composition of apatite and whitlockite in 12040.

K-spar: Brown et al. (1971) determined the composition of K-feldspar (3.7 wt. % BaO) and K-rich glass in 12040.

Chemistry

12040 has high MgO, and relatively high Cr₂O₃, apparently due to olivine and chromite accumulation (figure 8). The rare earth elements (Neal et al. 1994, Goles et al. 1971 and Schnetzler et al. 1971) are plotted in figure 7.

Radiogenic age dating

Lunar basalt 12040 has been dated by Rb-Sr by Papanastassiou and Wasserburg (1971a) (figure 9) and

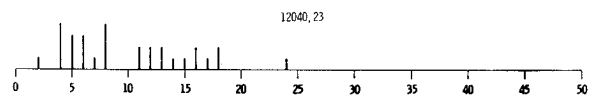

Figure 5: Histogram of Ni concentrations of metal grains in 12040 (lifted from Brett et al. 1971).

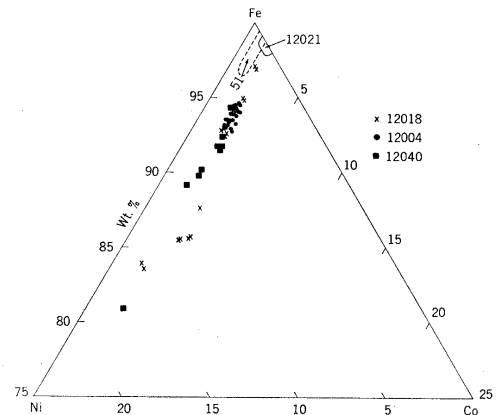

Figure 6: Ni and Co content of iron grains in 12040 (from Walter et al. 1971).

by Compston et al. (1971) (figure 10). Papanastassiou and Wasserburg coined the term “quintessence” for the most radiogenic mineral separate of this sample.

Cosmogenic isotopes and exposure ages

Burnett et al. (1975) determined an exposure age of 285 ± 50 m.y. by ⁸¹Kr/⁸³Kr.

Other Studies

Bogard et al. (1971) reported the content and isotopic composition of rare gases in 12040.

Processing

This sample was cracked open along a penetrating fracture and was not sawn. There are 18 thin sections.

Mineralogical Mode for 12040

	Neal et al. 1994	Baldrige et al. 1979	Papike et al. 1976	Newton et al. 1971	Brown et al. 1971
Olivine	22.7	22.72	25	20	29.3
Pyroxene	51.5	51.5	47.5	45	46
Plagioclase	21.6	21.6	23.4	20	19.8
Opagues			4.1	13	4.3
Ilmenite	2.3	2.3			
Chromite +Usp	1.2	1.2			
mesostasis	0.3	0.1		2	
“silica”	0.1	0.1			

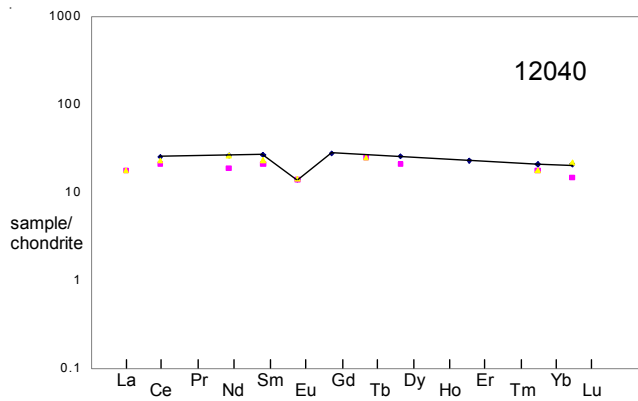

Figure 7: Normalized rare-earth-element diagram for 12040 (i.d. data by Schnetzler et al. 1971 connected by line).

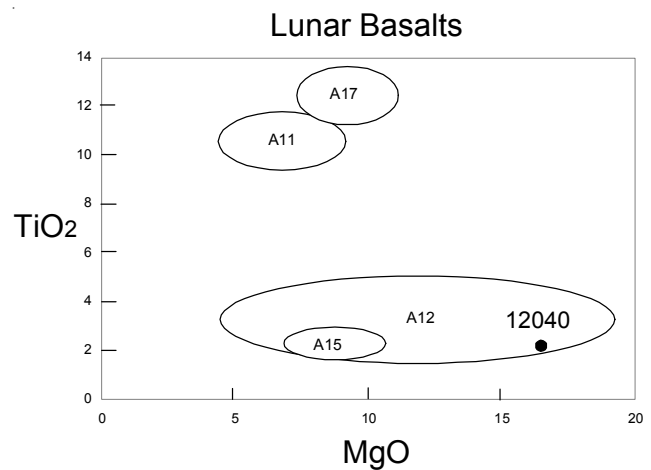

Figure 8: Composition of 12040 compared with other lunar basalts.

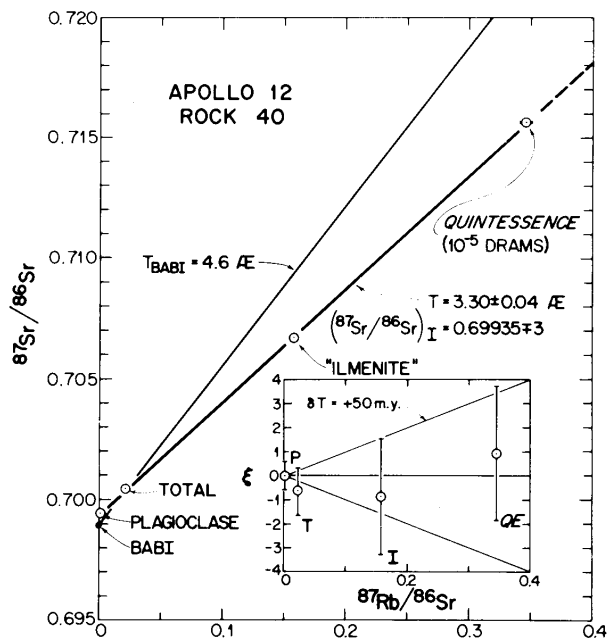

Figure 9: Rb-Sr isochron for 12040 (from Papanastassiou and Wasserburg 1971a).

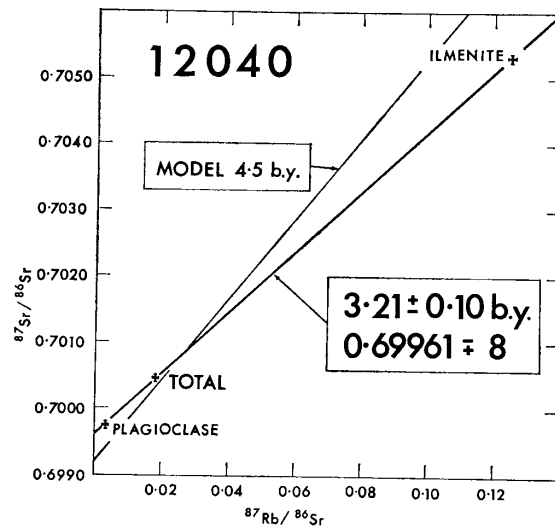
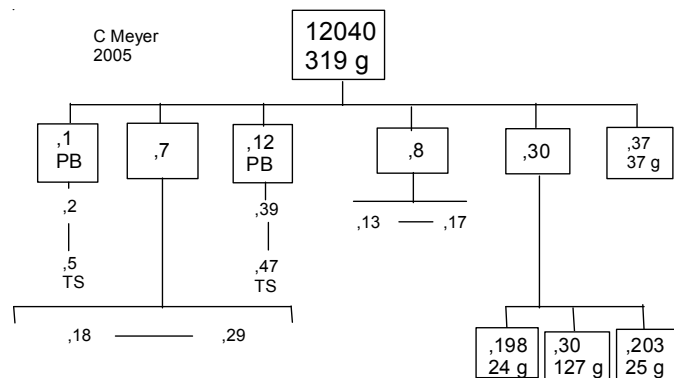

Figure 10: Rb-Sr isochron for 12040 (from Compston et al. 1971).

List of Photo #s for 12040.

- | | |
|-------------------|--------------|
| S69-60987 – 61010 | B & W |
| S69-63843 – 63846 | color mug |
| S70-22452 – 22459 | color mug |
| S70-19127 – 19137 | processing |
| S70-20742 | TS reflected |
| S70-20750 | TS |
| S70-20962 | TS |
| S70-44548 | TS reflected |
| S70-44555 | TS reflected |
| S70-49441 – 49444 | TS |
| S70-49807 – 49808 | TS |
| S74-33934 – 33937 | color ,30 |



Summary of Age Data for 12040

	Ar/Ar	Rb/Sr	Nyquist 1977 (recalculated)
	Papanastassiou and Wasserburg 1971a	3.30 ± 0.04 b.y.	
	Compston et al. 1971	3.21 ± 0.1	(3.15 ± 0.1)

Table 1. Chemical composition of 12040.

reference weight	Neal94 .654 g	Compston71		Scoon71	Kushiro71 1 g	Goles71			Schnetzler71 148 mg	Anders71	Brown71	
SiO ₂ %		44.08	(d)	43.89	(b)	43.68	(b)	44.93	43.43	44.28		
TiO ₂	2.6	(a)	2.41	(d)	2.74	(b)	2.48	(b)	2.3	2.27	2.28	
Al ₂ O ₃	7.8	(a)	7.18	(d)	7.41	(b)	7.35	(b)	6.97	6.67	7.22	
FeO	20.9	(a)	21.27	(d)	20.9	(b)	20.91	(b)	23	19.66	20.68	
MnO	0.26	(a)	0.28	(d)	0.26	(b)	0.26	(b)	0.24	0.24	0.24	
MgO	17.1	(a)	16.21	(d)	16.1	(b)	16.69	(b)				
CaO	6.9	(a)	8.1	(d)	7.87	(b)	7.81	(b)	7.83	8.26	7.4	
Na ₂ O	1.99	(a)	0.19	(d)	0.2	(b)	0.16	(b)	0.21	0.17	0.19	
K ₂ O	0.04	(a)	0.04	(d)	0.04	(b)	0.05	(b)				
P ₂ O ₅			0.06	(d)	0.07	(b)						
S %			0.04	(d)	0.06	(b)						
sum												
Sc ppm	42.6	(a)						36.7	38.4	37.5	(a)	
V	166	(a)							230	150	(a)	
Cr	4140	(a)			4790	(b)	4790	(b)	3560	4270	3650	(a)
Co	59.5	(a)						65.3	61.1	61.7	(a)	
Ni	101	(a)										
Cu												
Zn												
Ga												
Ge ppb												
As												
Se												
Rb			0.49	(d)	0.52	(c)						
Sr	94	(a)	80.6	(d)	80.9	(c)						
Y			22	(d)								
Zr			57	(d)				150	80	70	(a)	
Nb			2	(d)								
Mo												
Ru												
Rh												
Pd ppb												
Ag ppb												
Cd ppb												
In ppb												
Sn ppb												
Sb ppb												
Te ppb												
Cs ppm												
Ba	54	(a)	40	(d)				40	120	50	(a)	
La	4.3	(a)	2	(d)				5.43	3.49	4.21	(a)	
Ce	12.5	(a)	2	(d)				17	13	14	(a)	
Pr												
Nd	8.8	(a)						9	12	12	(a)	
Sm	3.1	(a)						4.3	2.87	3.46	(a)	
Eu	0.79	(a)						0.93	0.715	0.813	(a)	
Gd										5.6	(c)	
Tb	0.92	(a)						1.26	0.81	0.92	(a)	
Dy	5.2	(a)								6.36	(c)	
Ho												
Er										3.71	(c)	
Tm												
Yb	2.9	(a)						3.66	2.69	2.94	(a)	
Lu	0.37	(a)						0.629	0.525	0.54	(a)	
Hf	2.4	(a)						2.76	2.06	2.34	(a)	
Ta	0.3	(a)						0.4	0.4	0.33	(a)	
W ppb												
Re ppb												
Os ppb												
Ir ppb												
Pt ppb												
Au ppb												
Th ppm	0.47	(a)						1.2	0.9	1.1	(a)	
U ppm												

technique: (a) INAA, (b) classical chemical, (c) IDMS, (d) XRF, (e) RNAA

THE CHIPPING OF LUNAR ROCK 12040.0

DRAWING COMPLETED JUNE 25, 70
REVISED PER BOB CLARK JULY 6, 70

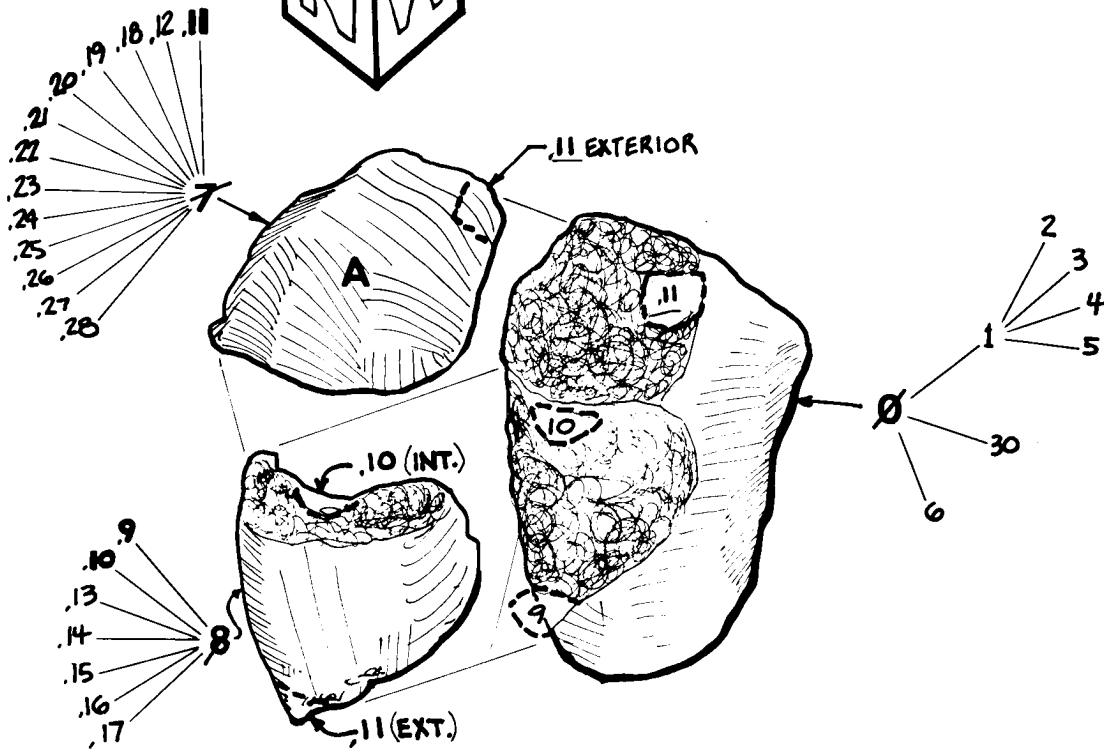
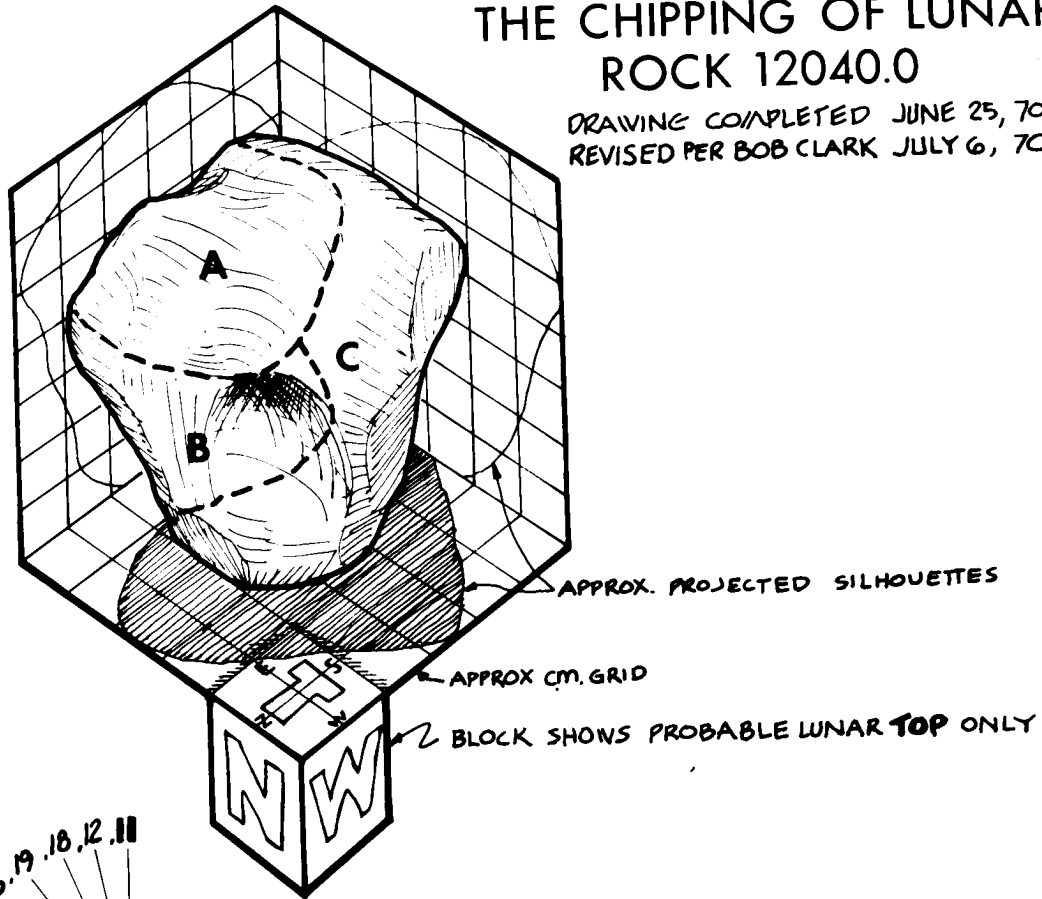

References for 12040

- Anders E., Ganapathy R., Keays R.R., Laul J.C., and Morgan J.W. (1971) Volatile and siderophile elements in lunar rocks: Comparison with terrestrial and meteoritic basalts. *Proc. 2nd Lunar Sci. Conf.* 1021-1036.
- Anders E., Ganapathy R., Krahenbuhl U. and Morgan J.W. (1973) Meteoritic material on the Moon. *The Moon* **8**, 3-24.
- Biggar G.M., O'Hara M.J., Peckett A. and Humphries D.J. (1971) Lunar lavas and the achondrites: Petrogenesis of protohypersthene basalts in the maria lava lakes. *Proc. Second Lunar Sci. Conf.* 617-643.
- Baldrige W.S., Beaty D.W., Hill S.M.R. and Albee A.L. (1979) The petrology of the Apollo 12 pigeonite basalt suite. *Proc. 10th Lunar Planet. Sci. Conf.* 141-179.
- Bogard D.D., Funkhouser J.G., Schaeffer O.A. and Zahringer J. (1971) Noble gas abundances in lunar material-cosmic ray spallation products and radiation ages from the Sea of Tranquillity and the Ocean of Storms. *J. Geophys. Res.* **76**, 2757-2779.
- Bombardier D.J., Norman M.D., Kamenetsky V.S. and Danyushevsky L.V. (2005) Major element and primary sulfur concentrations in Apollo 123 mare basalts: The view from melt inclusions. *Meteoritics & Planet. Sci.* **40**, 679-693.
- Brett R., Butler P., Meyer C., Reid A.M., Takeda H. and Williams R. (1971) Apollo 12 igneous rocks 12004, 12008, 12009 and 12022: A mineralogical and petrological study. *Proc. 2nd Lunar Sci. Conf.* 301-317.
- Brown G.M., Emeleus C.H., Holland J.G., Peckett A. and Phillips R. (1971) Picrite basalts, ferrobasalts, feldspathic norites, and rhyolites in a strongly fractionated lunar crust. *Proc. 2nd Lunar Sci. Conf.* 583-600.
- Champness P.E., Dunham A.C., Gibb F.G.F., Giles H.N., MacKenzie W.S., Stumpel E.F. and Zussman J. (1971) Mineralogy and petrology of some Apollo 12 lunar samples. *Proc. 2nd Lunar Sci. Conf.* 359-376.
- Compston W., Berry H., Vernon M.J., Chappell B.W. and Kay M.J. (1971) Rubidium-strontium chronology and chemistry of lunar material from the Ocean of Storms. *Proc. 2nd Lunar Sci. Conf.* 1471-1485.
- French B.M., Walter L.S., Heinrich K.F.J., Loman P.D., Doan A.S. and Adler I. (1972) Composition of major and minor minerals in five Apollo 12 crystalline rocks. NASA SP-306
- Goles G.G., Duncan A.R., Lindstrom D.J., Martin M.R., Beyer R.L., Osawa M., Randle K., Meek L.T., Steinborn T.L. and McKay S.M. (1971) Analyses of Apollo 12 specimens: Compositional variations, differentiation processes, and lunar soil mixing models. *Proc. 2nd Lunar Sci. Conf.* 1063-1081.
- James O.B. and Wright T.L. (1972) Apollo 11 and 12 mare basalts and gabbros: Classification, compositional variations and possible petrogenetic relations. *Geol. Soc. Am. Bull.* **83**, 2357-2382.
- Kushiro I. and Haramura H. (1971) Major element variation and possible source materials of Apollo 12 crystalline rocks. *Science* **171**, 1235-1237.
- Kushiro I., Nakamura Y., Kitayama K. and Akimoto S-I. (1971) Petrology of some Apollo 12 crystalline rocks. *Proc. 2nd Lunar Sci. Conf.* 481-495.
- LSPET (1970) Preliminary examination of lunar samples from Apollo 12. *Science* **167**, 1325-1339.
- Neal C.R., Hacker M.D., Snyder G.A., Taylor L.A., Liu Y.-G. and Schmitt R.A. (1994a) Basalt generation at the Apollo 12 site, Part 1: New data, classification and re-evaluation. *Meteoritics* **29**, 334-348.
- Neal C.R., Hacker M.D., Snyder G.A., Taylor L.A., Liu Y.-G. and Schmitt R.A. (1994b) Basalt generation at the Apollo 12 site, Part 2: Source heterogeneity, multiple melts and crustal contamination. *Meteoritics* **29**, 349-361.
- Newton R.C., Anderson A.T. and Smith J.V. (1971) Accumulation of olivine in rock 12040 and other basaltic fragments in the light of analysis and syntheses. *Proc. Second Lunar Sci. Conf.* 575-582.
- Papanastassiou D.A. and Wasserburg G.J. (1971a) Lunar chronology and evolution from Rb-Sr studies of Apollo 11 and 12 samples. *Earth Planet. Sci. Lett.* **11**, 37-62.
- Papike J.J., Hodges F.N., Bence A.E., Cameron M. and Rhodes J.M. (1976) Mare basalts: Crystal chemistry,

mineralogy and petrology. *Rev. Geophys. Space Phys.* **14**, 475-540.

Schnetzler C.C. and Philpotts J.A. (1971) Alkali, alkaline earth, and rare earth element concentrations in some Apollo 12 soils, rocks, and separated phases. *Proc. 2nd Lunar Sci. Conf.* 1101-1122.

Scoon J.H. (1971) Chemical analyses of lunar samples 12040 and 12064. *Proc. 2nd Lunar Sci. Conf.* 1259-1260.

Walter L.S., French B.M., Heinrich K.F.J., Lowman P.D., Doan A.S. and Adler I. (1971) Mineralogical studies of Apollo 12 samples. *Proc. Second Lunar Sci. Conf.* 343-358.